

CLARIDGE SERIES 3
 SCALE - 1/2" = 1"
 MOUNTING ANGLE CLIP

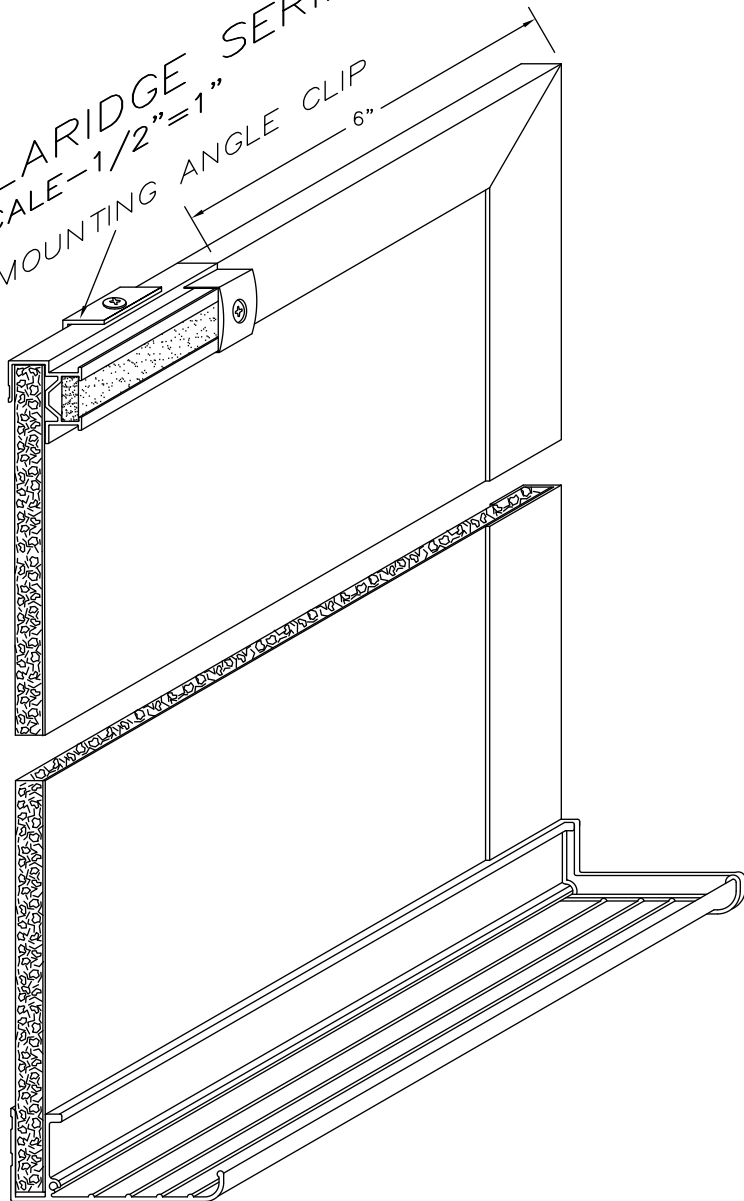

TYPE A

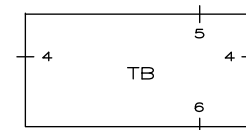

TYPE CO



TYPE D

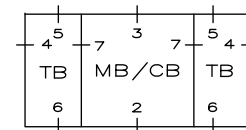

TYPE C

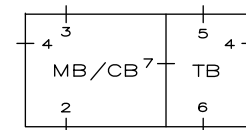

TYPE BR
(BL REVERSE)

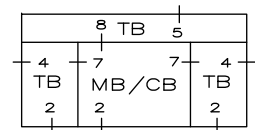

TYPE F

PANEL SIZES UP TO 4'-0" HIGH X 16'-0" WIDE IN ONE PIECE
 ALL PANELS ARE APPROX. 1/2" THICK OVERALL

PORCELAIN ENAMEL PANEL TYPE	CORE	PANEL BACKING
VITRACITE CHALKBOARD	STANDARD CORE MDF	MOISTURE BARRIER BACK
LCSII MARKERBOARD	STANDARD FORMALDEHYDE FREE CORE DURACORE	OPTIONAL FOIL SHEET ALUMINUM STEEL

TACKBOARD PANELS	SERIES NUMBER	PANEL MAKE-UP
CLARIDGE CORK	#1100	CLARIDGE COLORED CORK ON HARDBOARD
TAN NUCORK	#550	TAN NUCORK ON HARDBOARD
FABRICORK	#1550	VINYL FABRIC ON CORK UNDERLAY ON HARDBOARD
FABRICORK	#1380A	VINYL FABRIC ON DURACORE
DESIGNER SERIES	#3102	DESIGNER FABRIC ON CORK UNDERLAY ON HARDBOARD
HOOK-FAB	#934	HOOK-FAB ON CORK UNDERLAY ON HARDBOARD

CLARIDGE SERIES 3 FACTORY BUILT UNITS

TRIM SECTION DETAILS
SCALE=FULL SIZE

